









 Ø6,3x50 mm A1 x 48	 Ø12 mm A2 x 48	 4 mm A3 x 1	 Ø15x12 mm B1 x 16	 Ø5x44 mm B2 x 16
 Ø20 mm B3 x 16	 Ø4x16 mm D1 x 64	 Ø3x25 mm D2 x 14	 Ø1,6x25 mm F x 150	 Ø8x36 mm G x 44
 K x 4	 Ø5x16 mm L x 16	 M x 4	 N x 5	 Z x 14

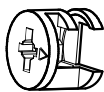
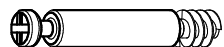

Box 1/3

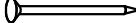
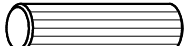
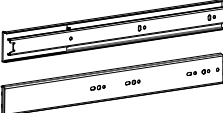
378x70x16 mm

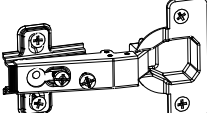
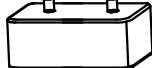

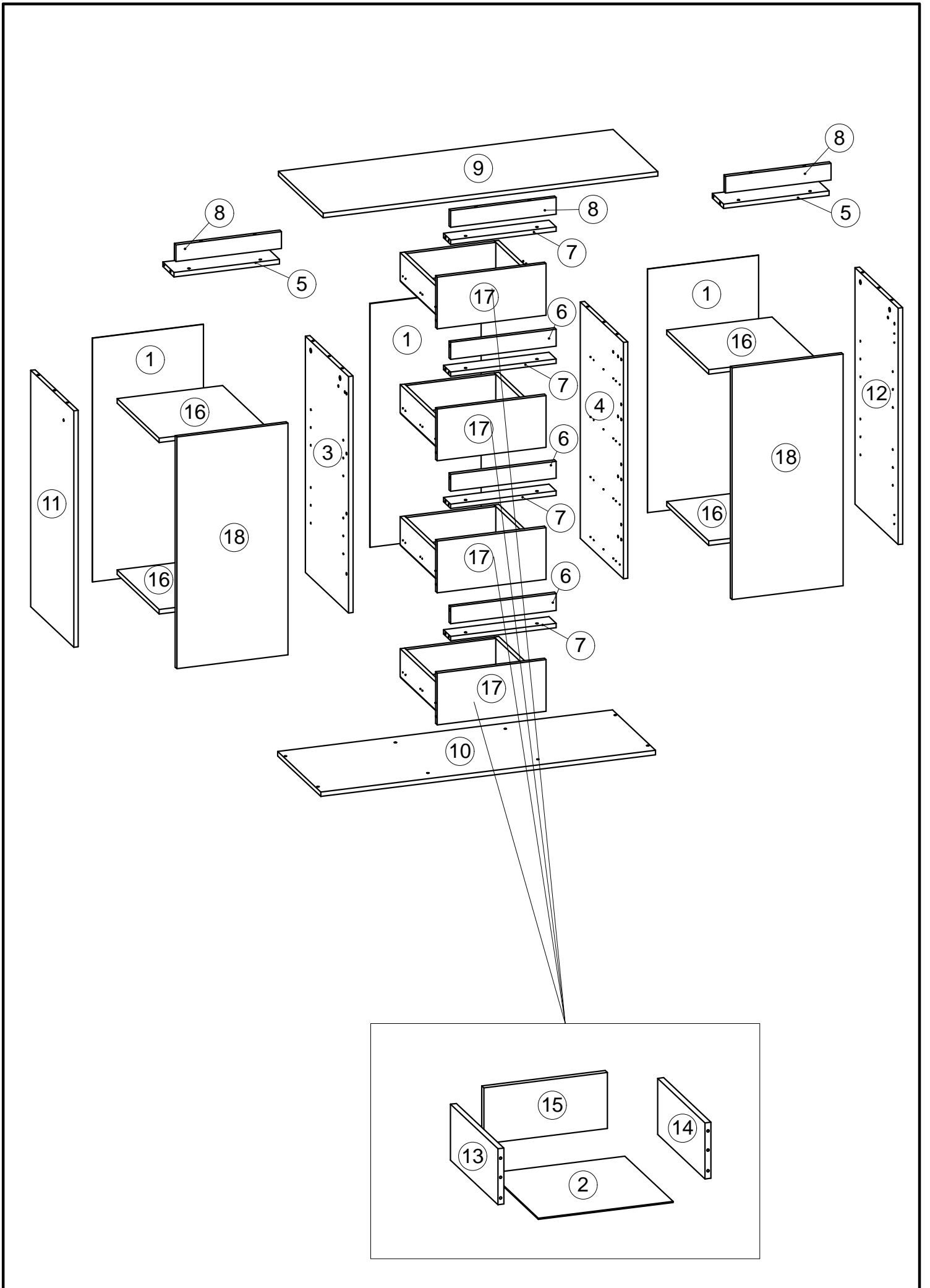
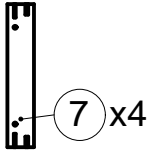
847x424x16 mm

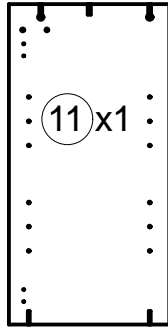

847x424x16 mm

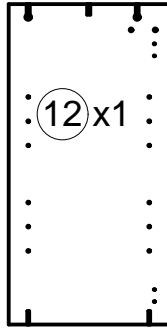

414x378x16 mm

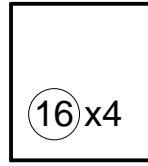

389x184x16 mm

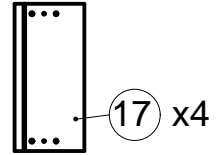

Fittings & Tools

Box 2/3

847x424x16 mm

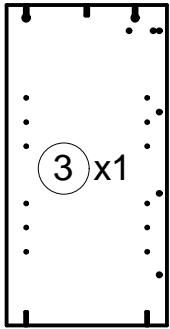

847x424x16 mm

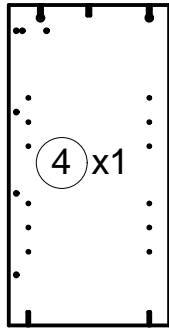

378x110x16 mm

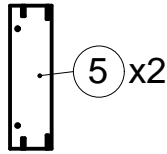

378x60x16 mm

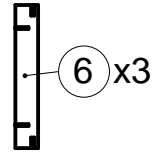

397x829x16 mm

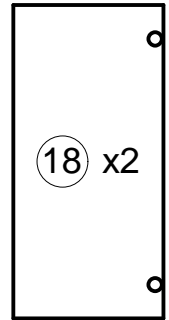

378x60x16 mm

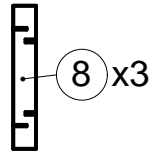

Box 3/3

1199x440x16 mm

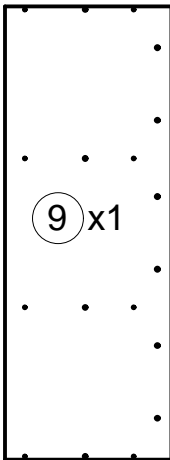

1199x424x16 mm

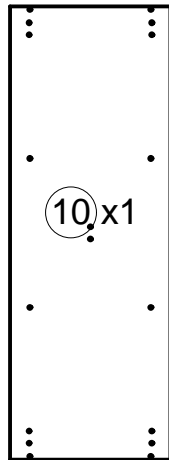

400x100x16 mm

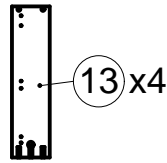

873x398x3 mm

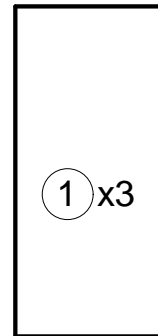

406x351x3 mm

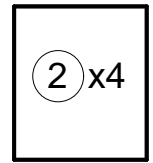

400x100x16 mm

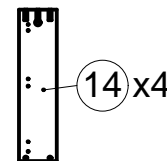

321x100x16 mm

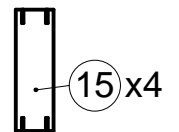

1



B1 x 2



G x 1



L x 4

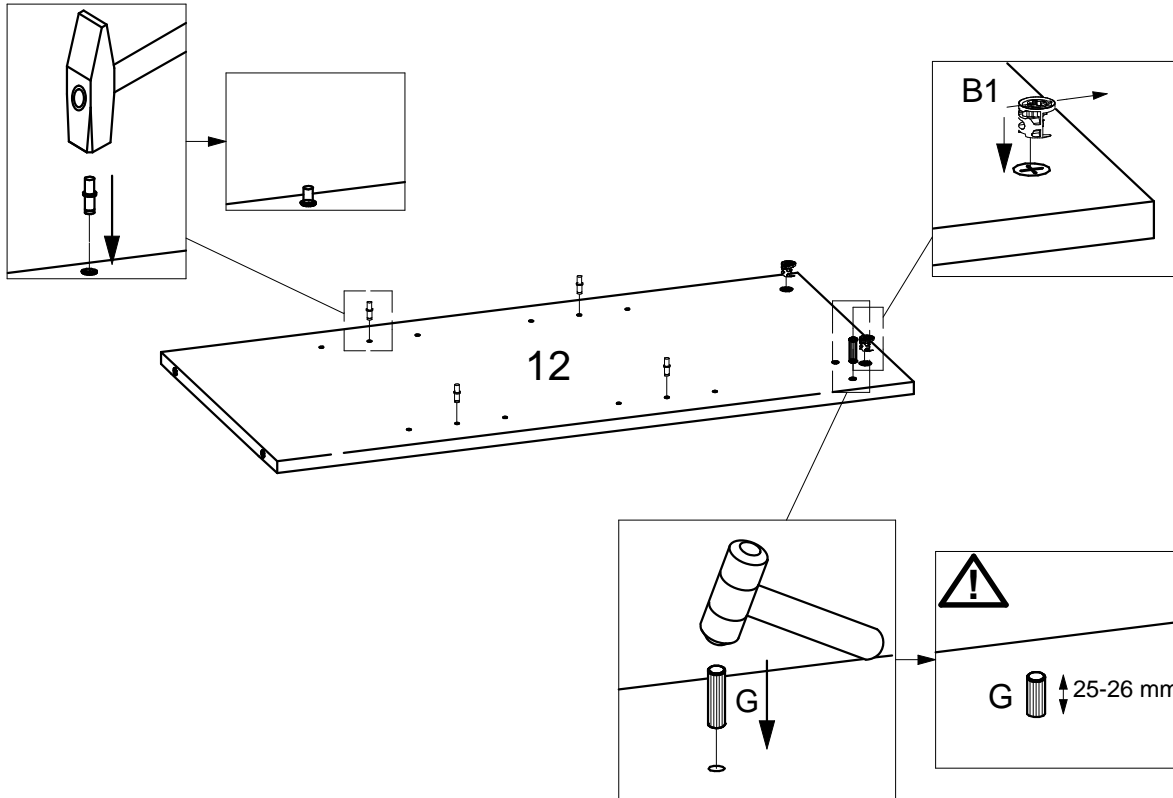
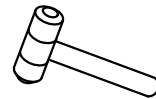
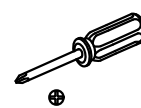
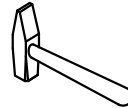

2



D1 x 4



M.1 x 2

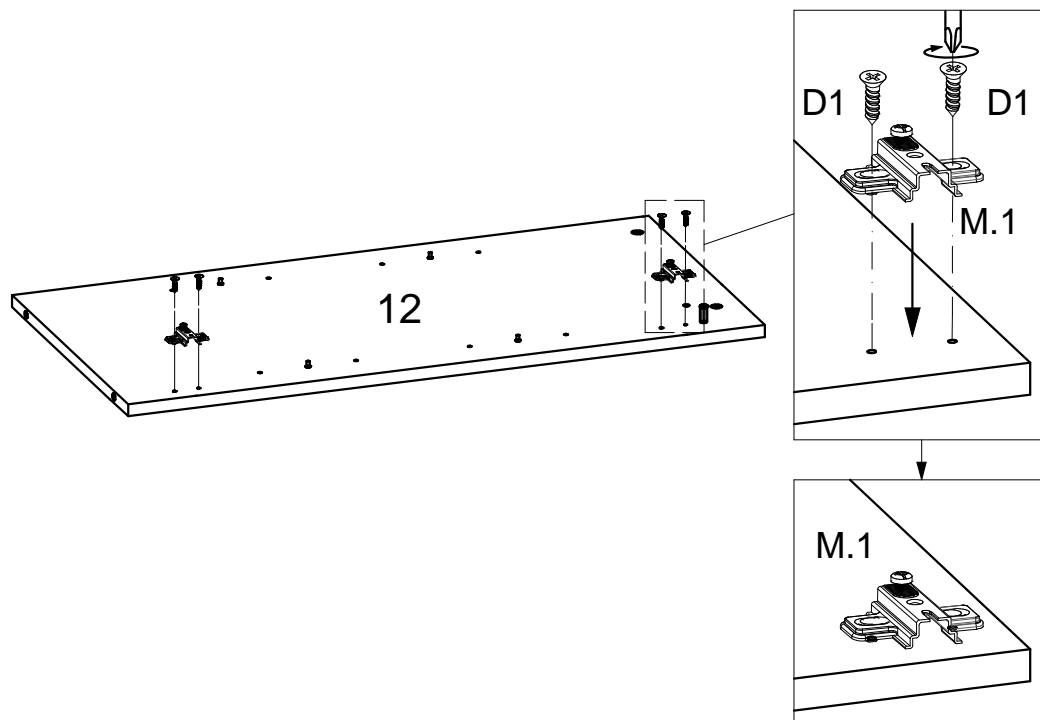
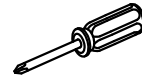

3



B1 x 2

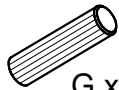

G x 1



L x 4

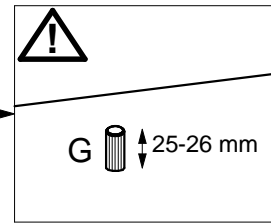
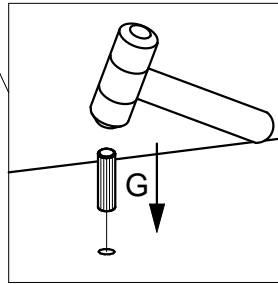
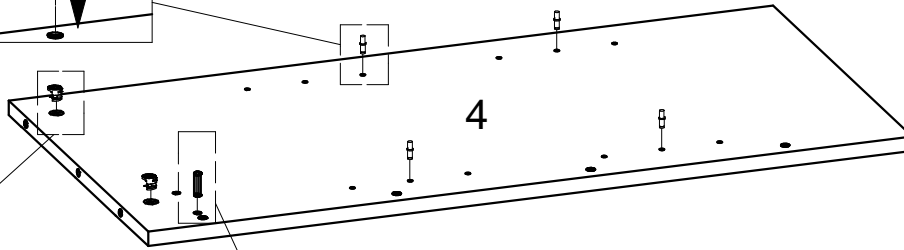
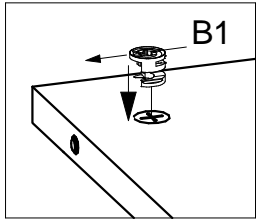
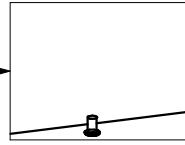
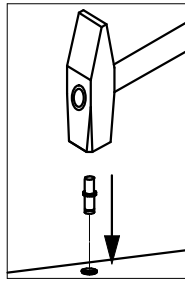
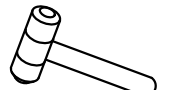
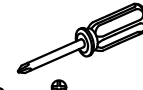
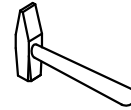

4



G x 7

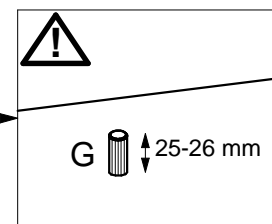
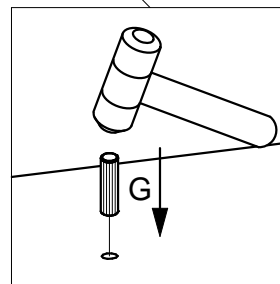
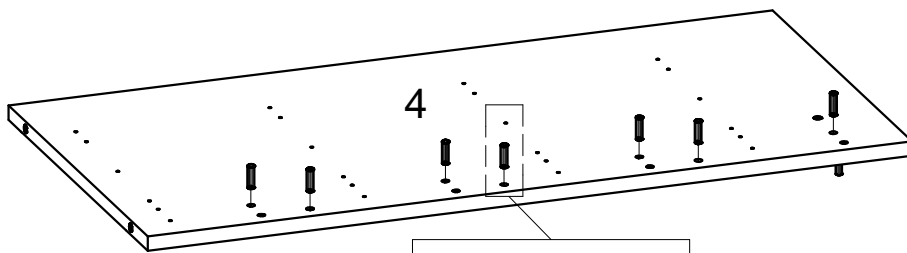
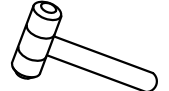

5



B1 x 2



G x 1



L x 4

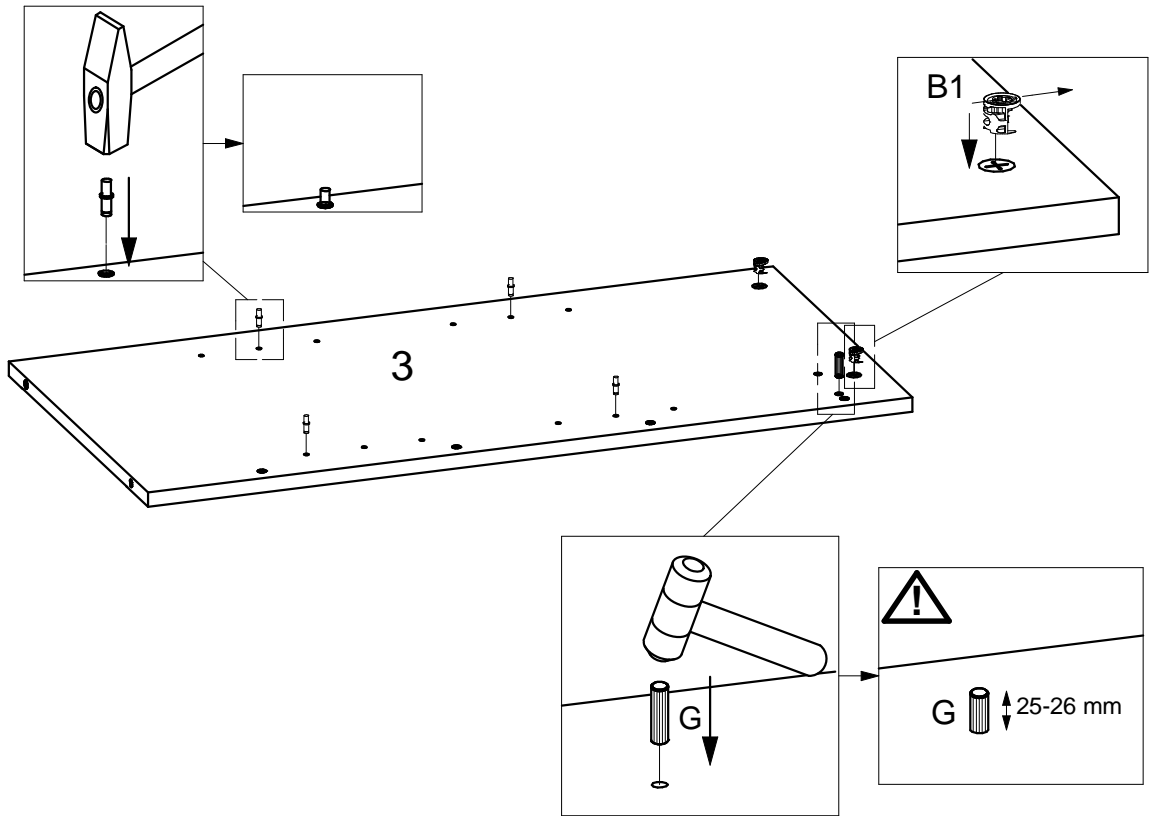
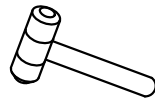
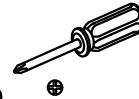
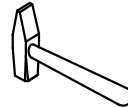

6



G x 7

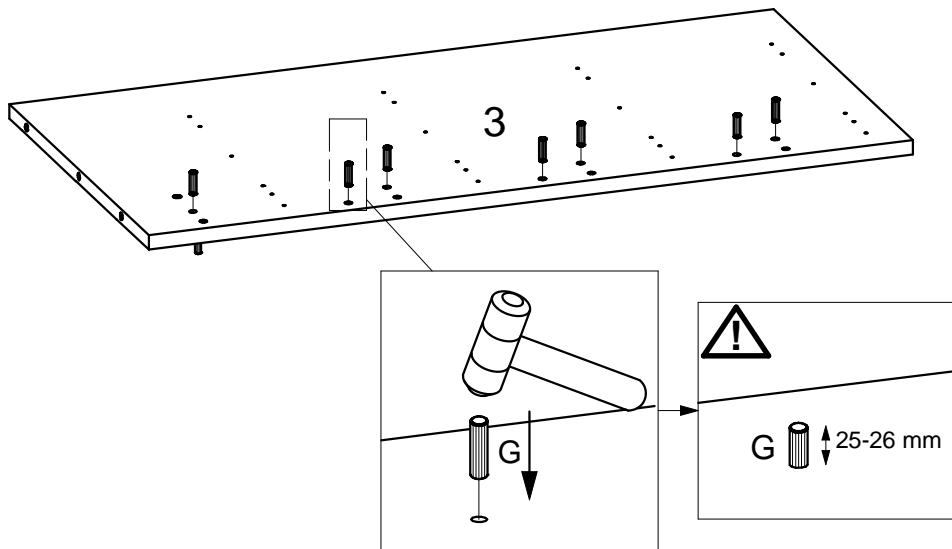
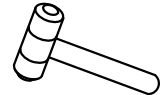

7



B1 x 2



G x 1



L x 4

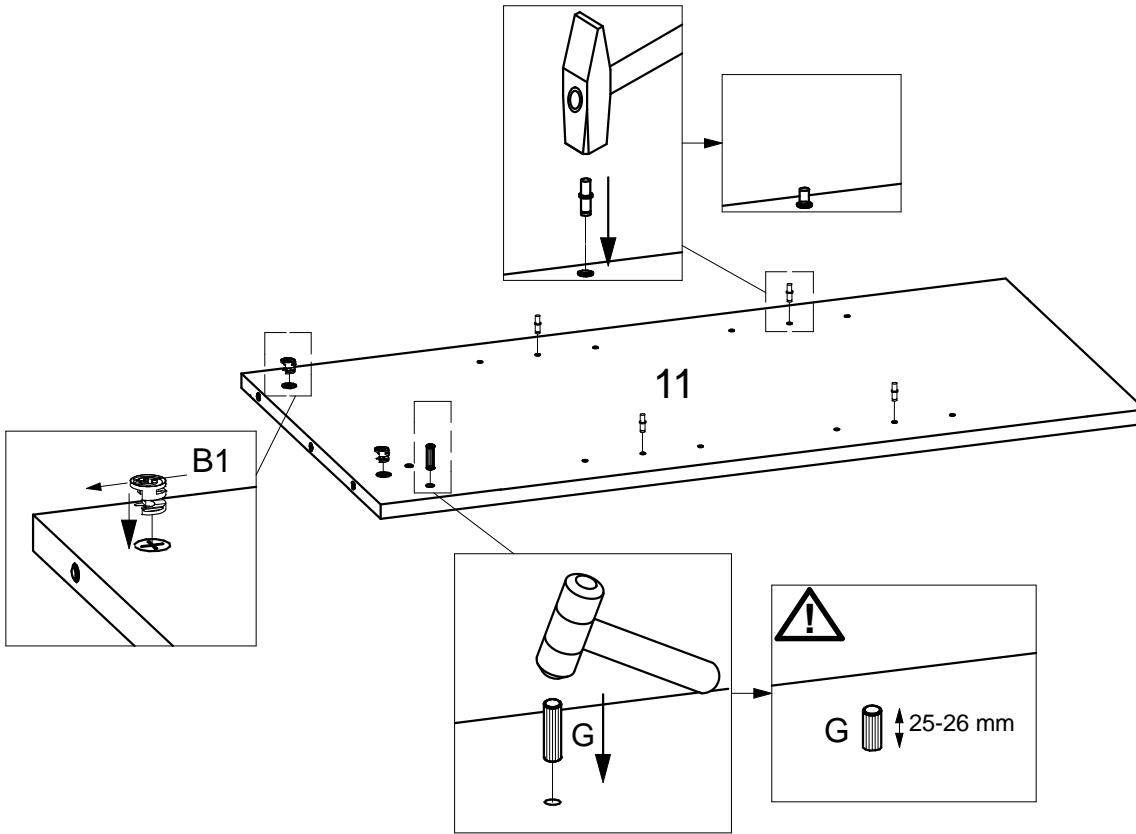
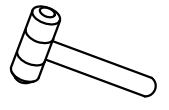
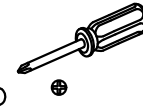
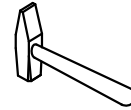

8



D1 x 4



M.1 x 2

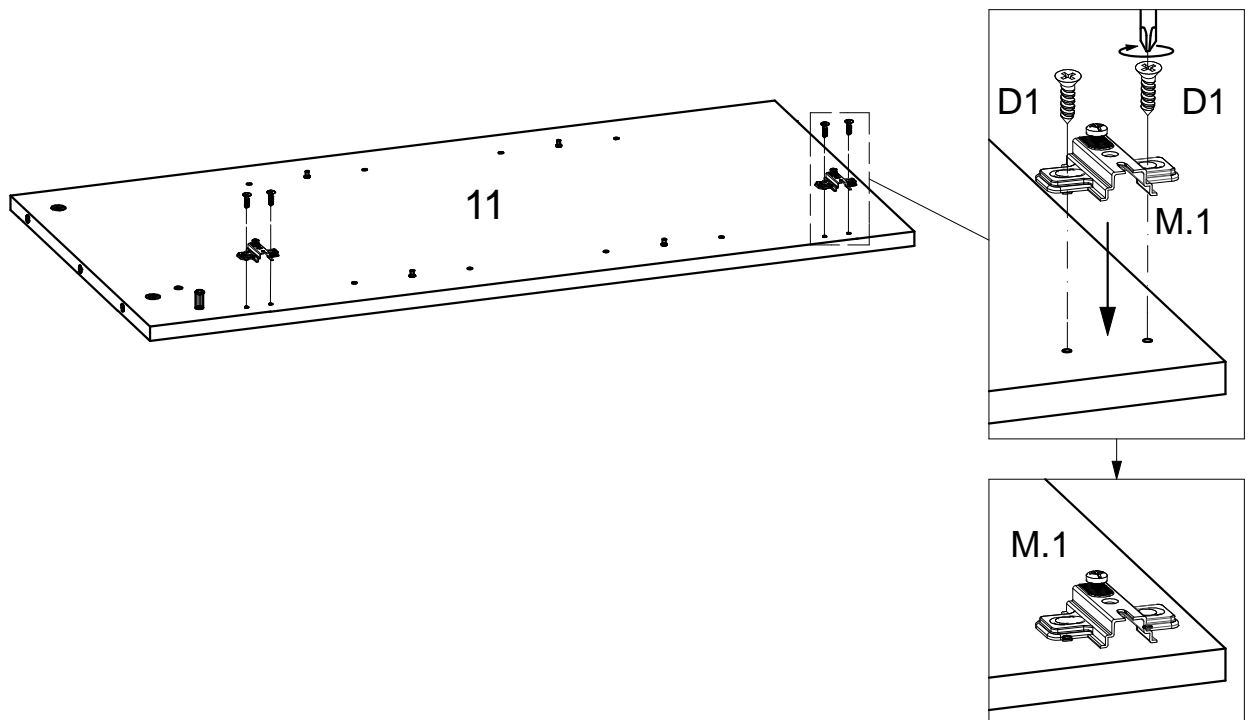
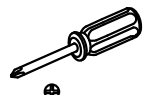

9

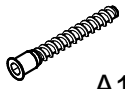

A1 x 4



A2 x 4



A3 x 1

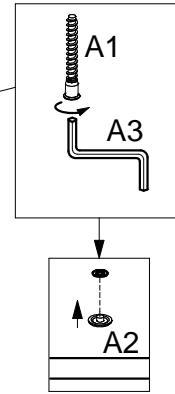
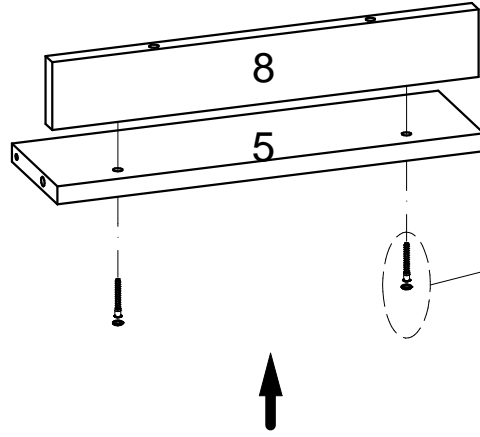

x 2

10



A1 x 2



A2 x 2



A3 x 1

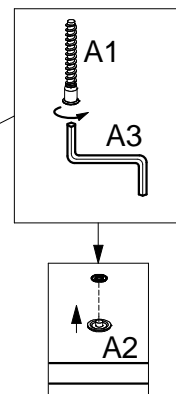
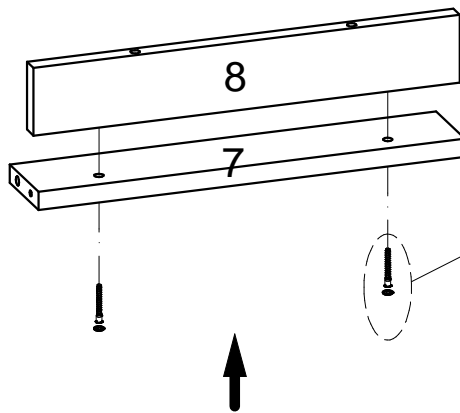

11

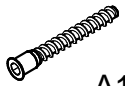

A1 x 6



A2 x 6



A3 x 1

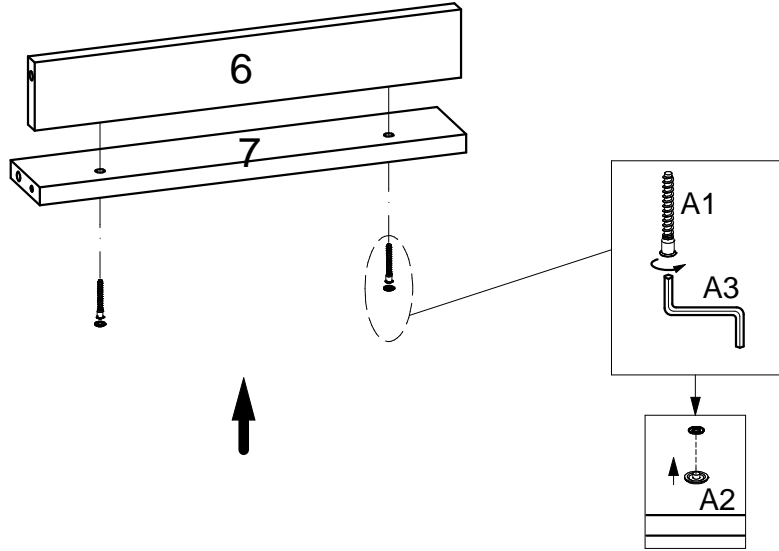

x 3

12

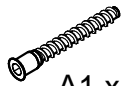

A1 x 8



A2 x 8



A3 x 1

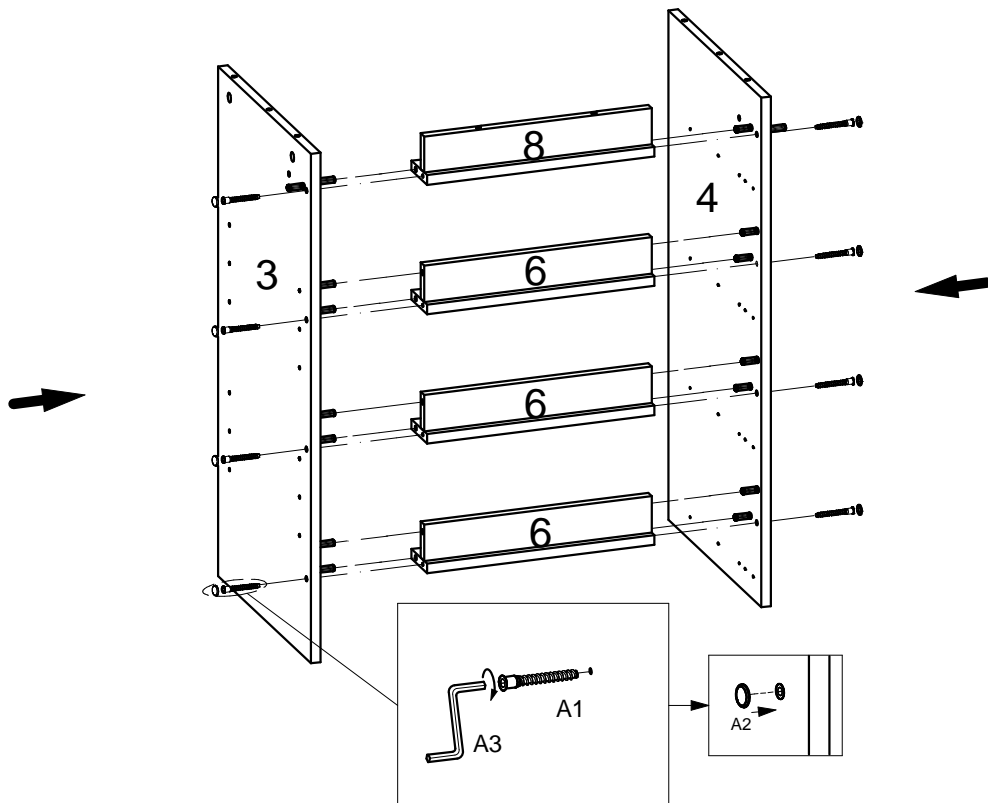
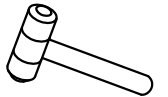

13

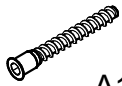

A1 x 4



A2 x 4



A3 x 1

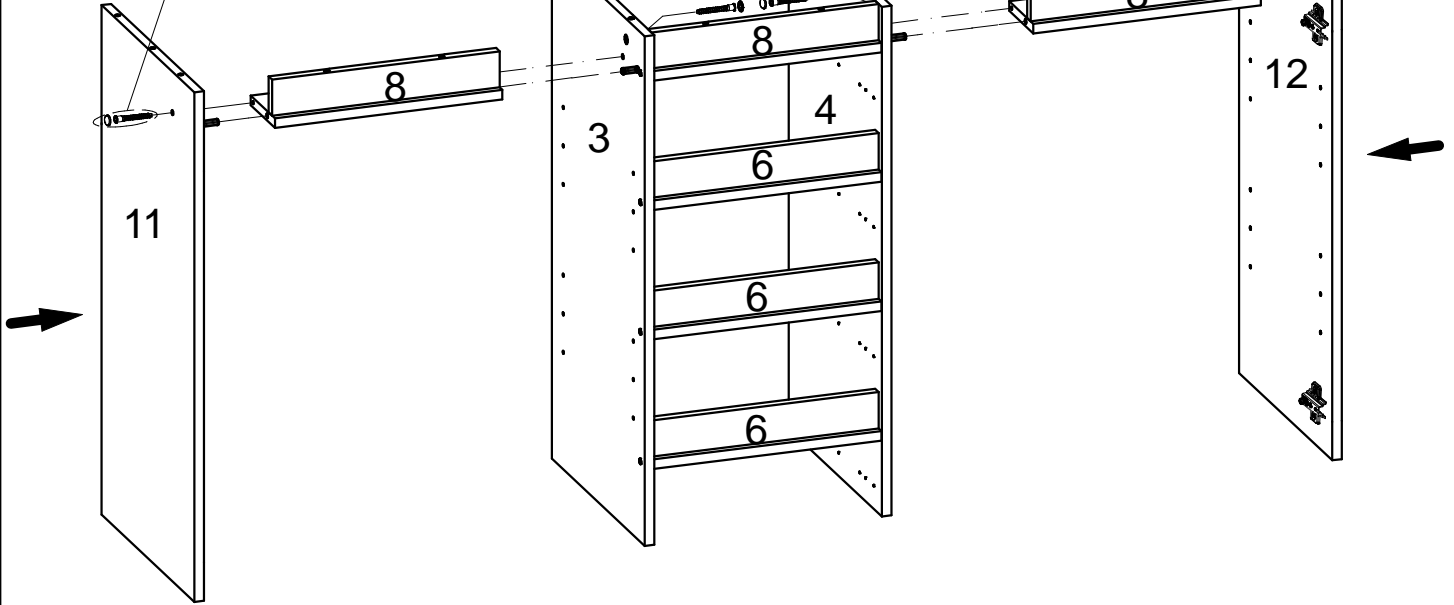
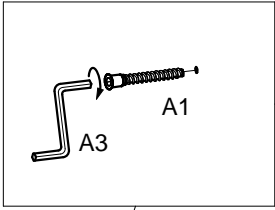
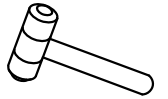

14

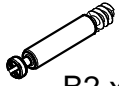

B2 x 8



G x 10

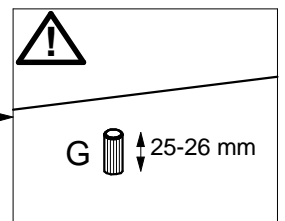
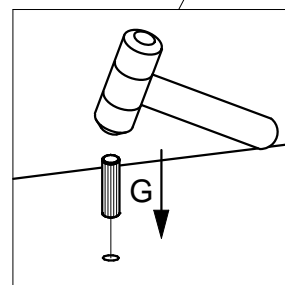
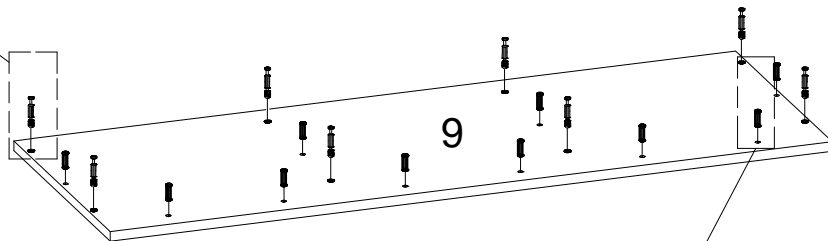
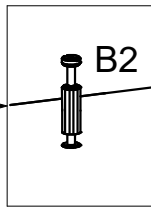
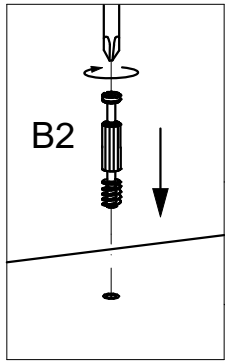
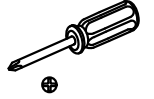
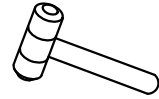

15



A1 x 8



A2 x 8



A3 x 1



B3 x 8

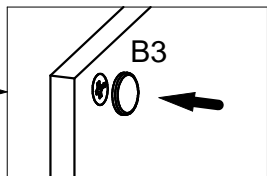
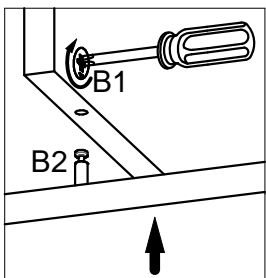
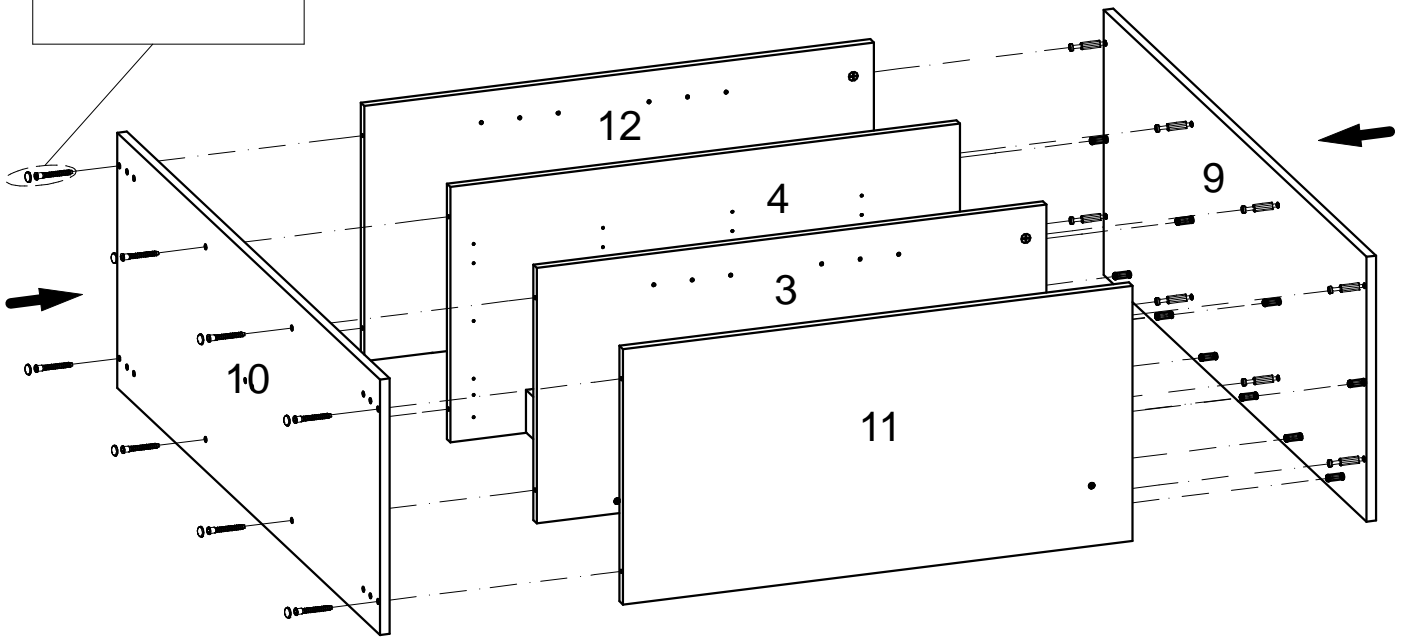
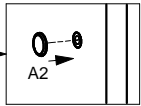
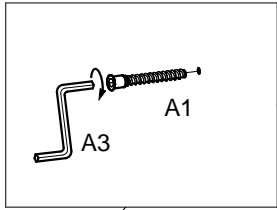
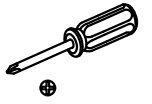
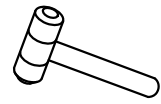

16

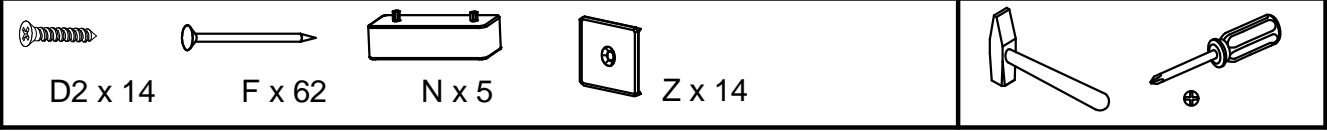

⚠ XX=YY≅90°

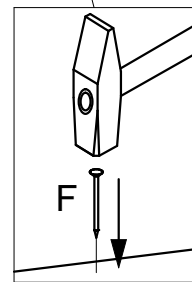
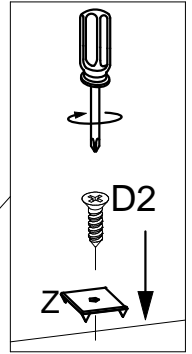
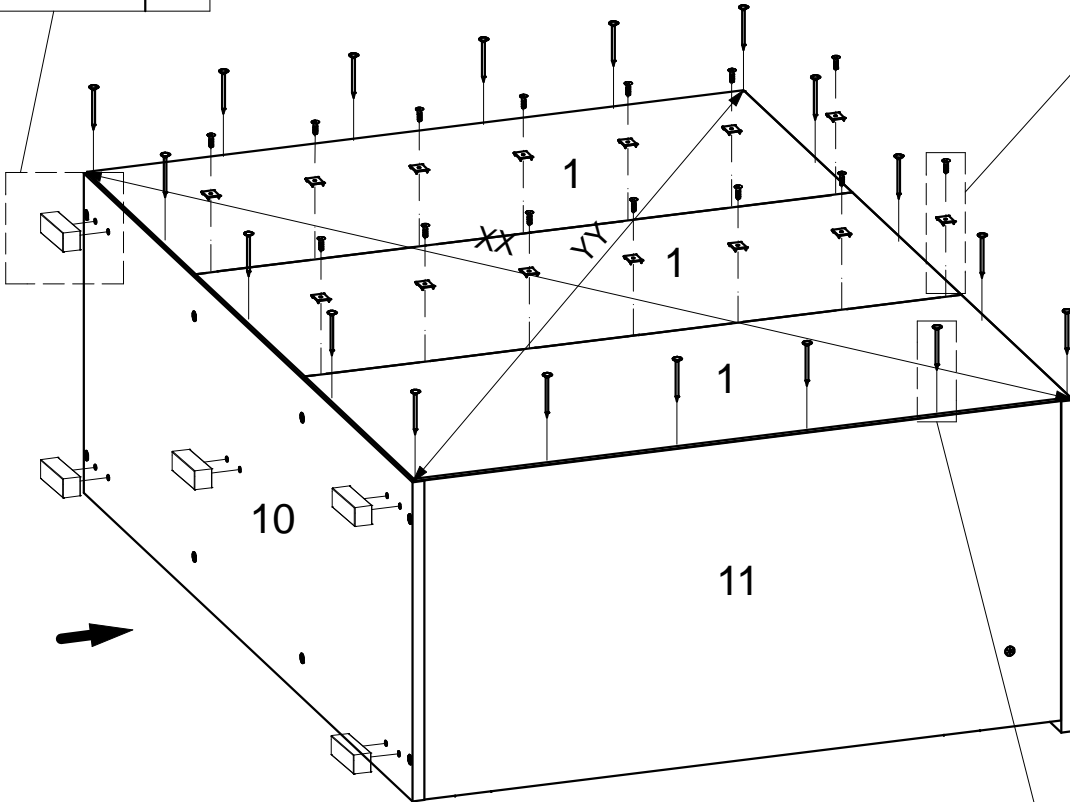
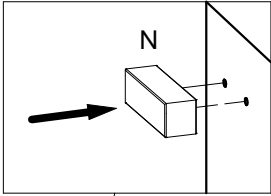

17



D1 x 24

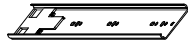

K.1 x 4



K.2 x 4

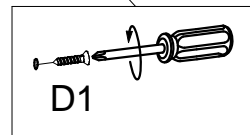
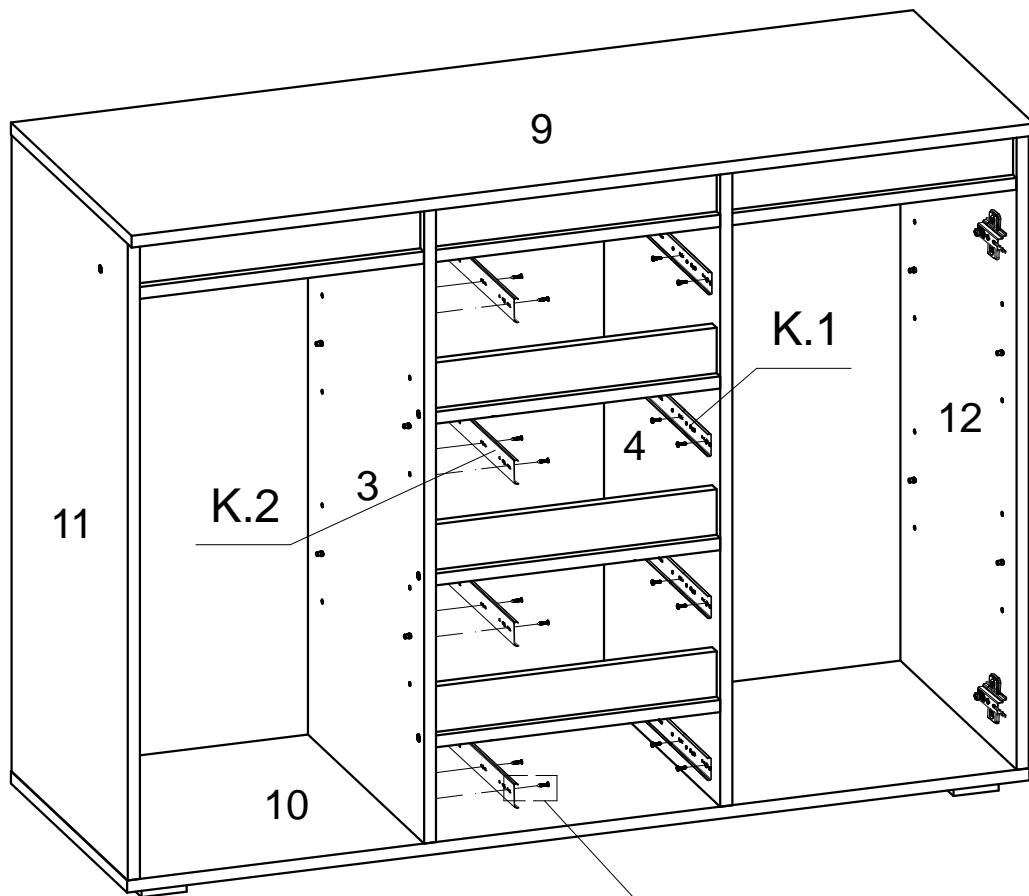
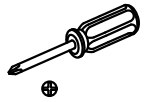

D1

18

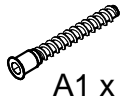

A1 x 16



A2 x 16



A3 x 1



B1 x 8

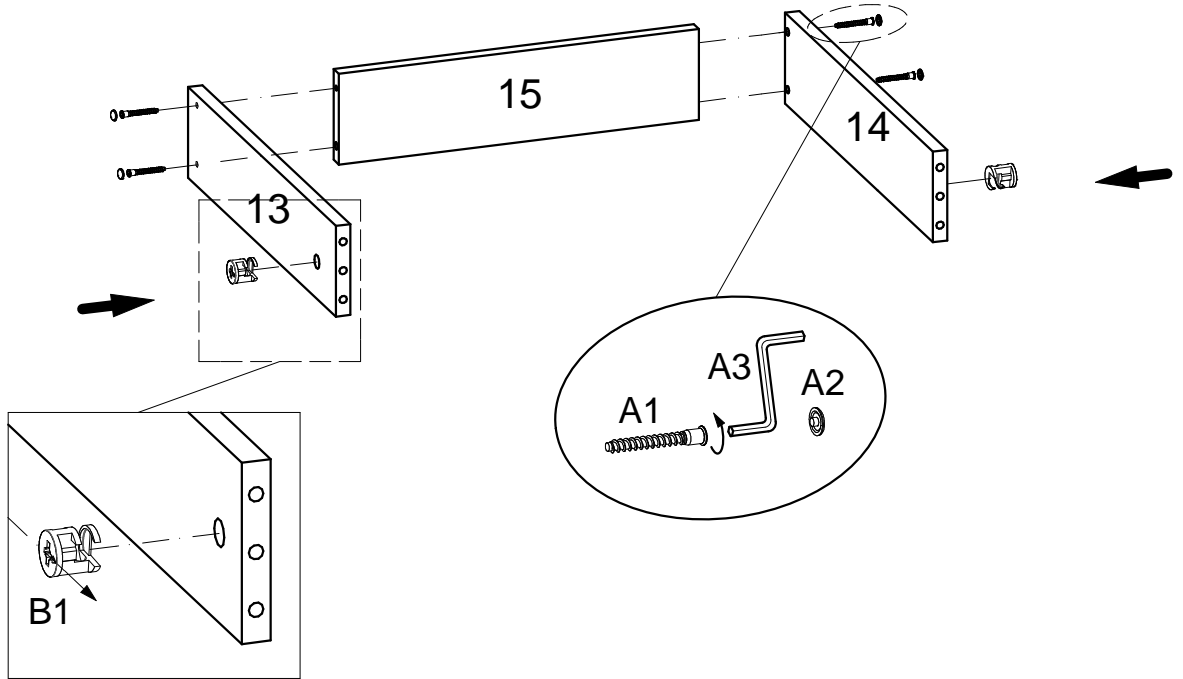

x 4

19

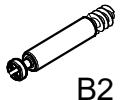

B2 x 8



B3 x 8



G x 16

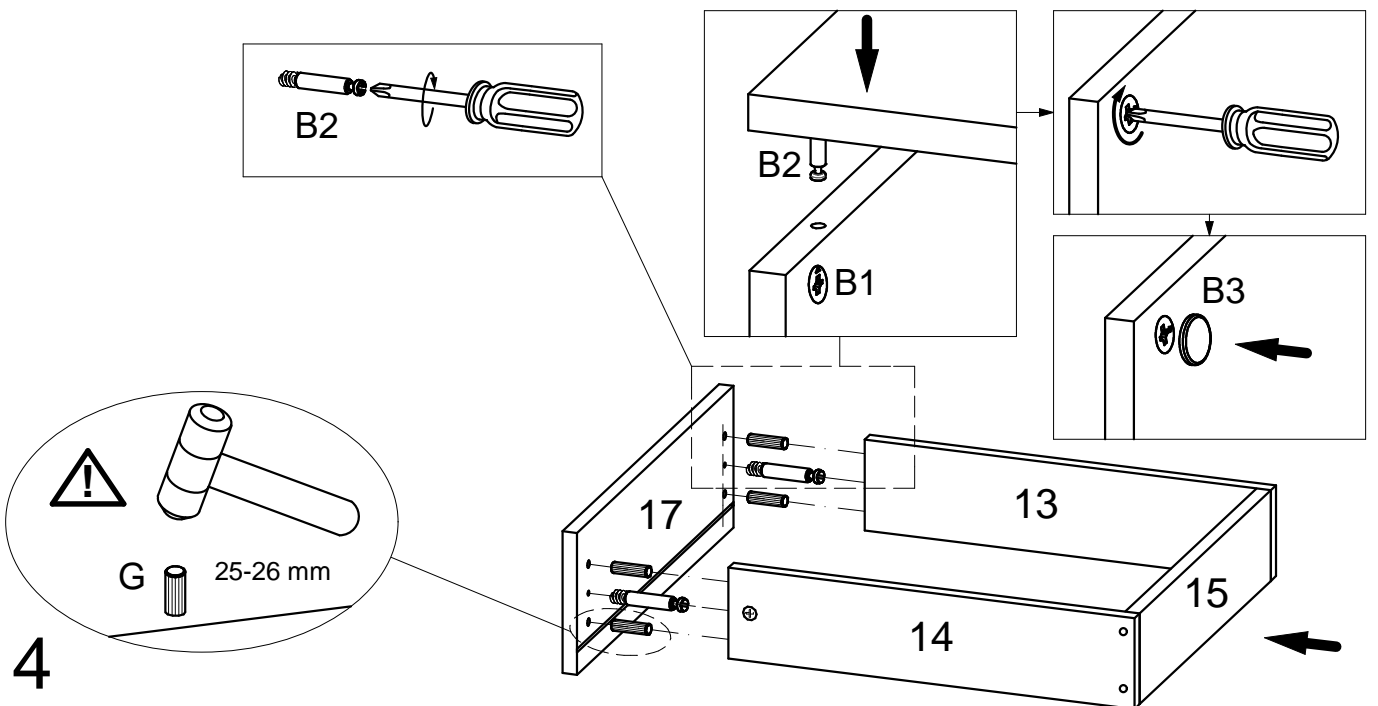
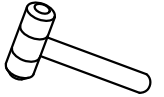
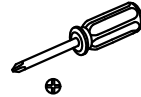

x 4

20

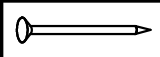

F x 88

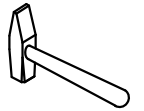

⚠ XX=YY≅90°

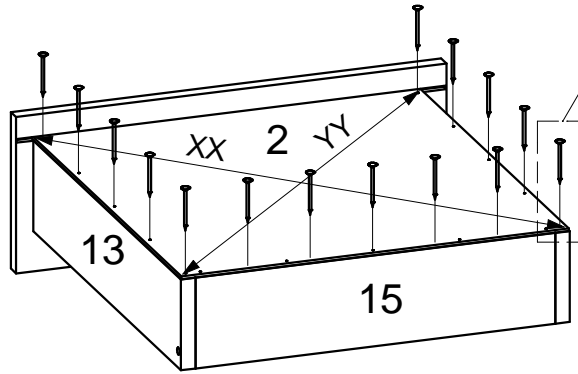

x 4

21



D1 x 24

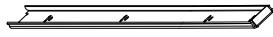

K.3 x 4



K.4 x 4

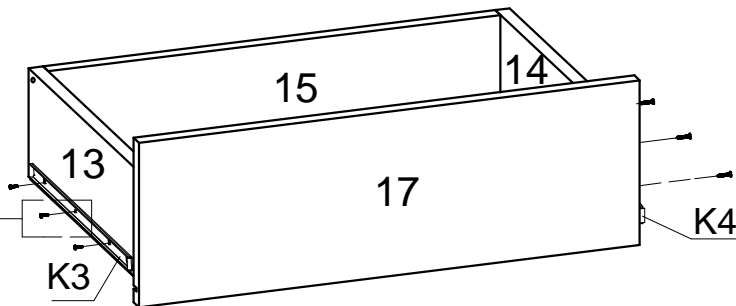
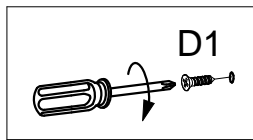
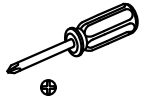

x 4

22



D1 x 8

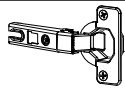

M.2 x 4

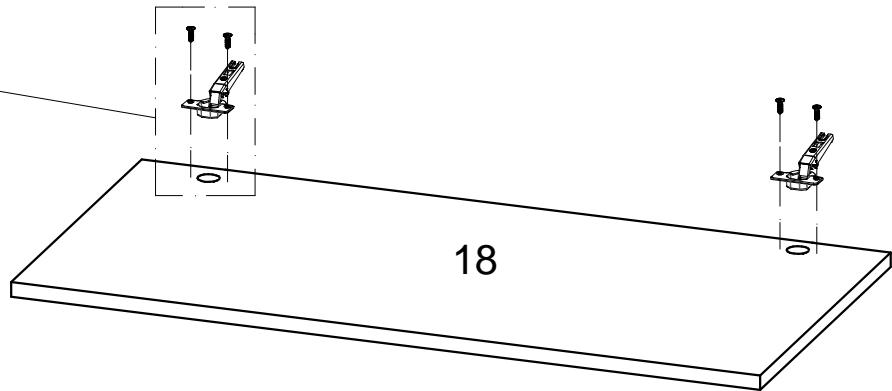
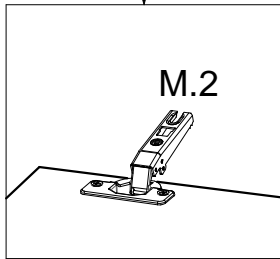
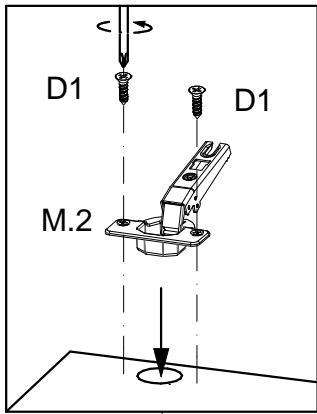
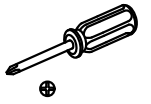

x 2

23

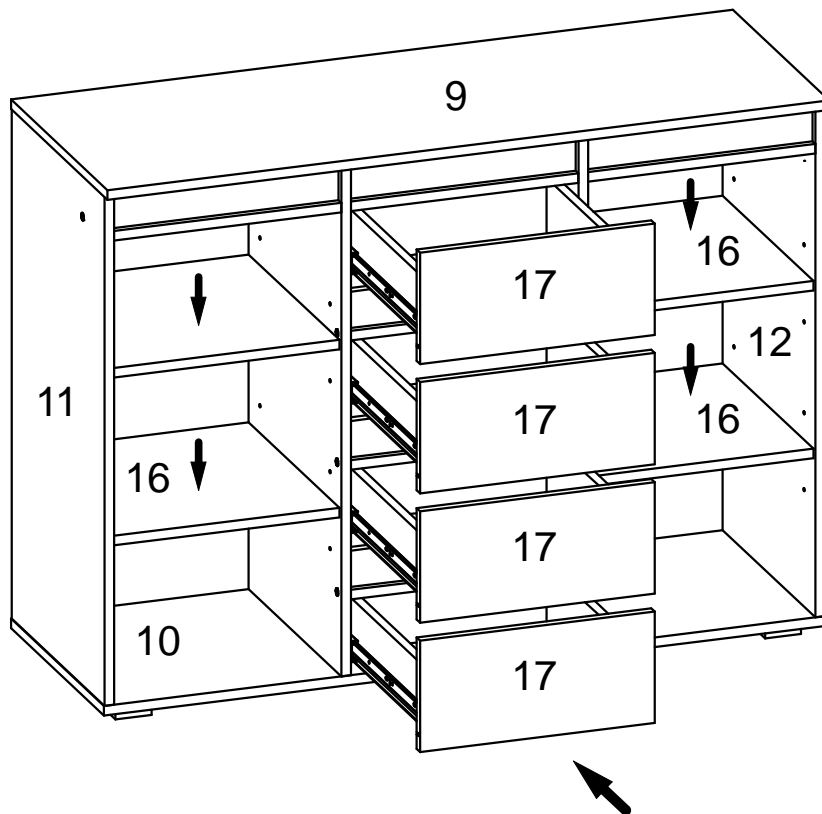

24

